

ART 40T

PN40 Brass Ball Valve

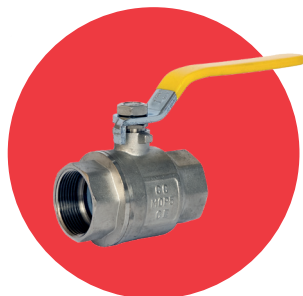

Features

- Screwed BSP Taper (ISO 7/1)
- Anti-blow-out stem
- PTFE seats & seals
- Full bore
- Locking lever, thermal extension (1/2" - 2" only) and tee handle (1/4" to 1" only) options available
- For details on handles refer to the Ball Valve Accessory datasheet

Accessory datasheet

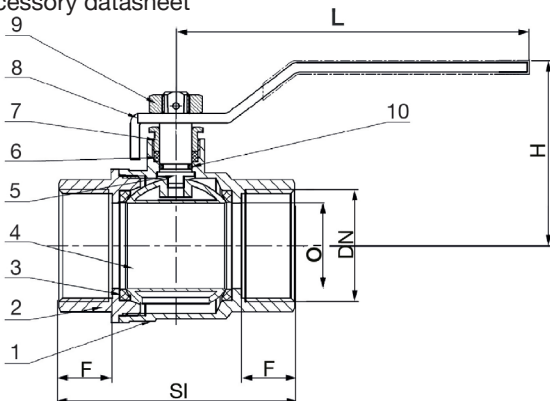

Technical data

Max pressure: 1/4" - 2" 40 Bar
 2 1/2" - 4" 25 Bar
 Working temp: -20°C to +140°C

Technical data - Gas distribution

Max pressure: 1/4" - 4" 5 Bar
 Working temp: -20°C to +60°C

DN	1/4"	3/8"	1/2"	3/4"	1"	1 1/4"	1 1/2"	2"	2 1/2"	3"	4"
O	10	10	14.5	19	24.5	31.5	40	49	62	73	90
F	11.5	11.5	15	18	19.5	20	21	26.5	31	36.8	41.6
SI	45	45	57	67	77	88	99	121	146	168	199
H	41	41	49	51	62	81	90	96	122	132	143
L	83	83	88	100	125	140	140	165	225	225	280
Kv	8	10	16	30	48	100	170	230	390	576	940
Kgs	0.14	0.14	0.20	0.26	0.41	0.61	0.95	1.35	2.50	3.80	6.80

N.	Part Name	Materials
1	Body	Brass / Nickel Plated CW617N
2	Cap	Brass / Nickel Plated CW617N
3	Seat	PTFE
4	Ball	Brass / Chrome Plated CW617N
5	Stem	Brass CW617N
6	Packing	PTFE
7	Lock Nut	Brass CW617N
8	Handle	Carbon Steel A3
9	Nut	Carbon Steel A3
10	O-Ring	NBR

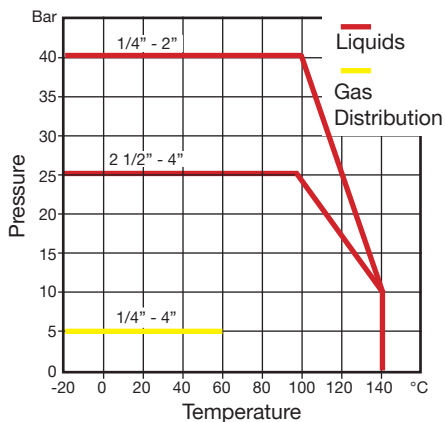

V2. Dimensions in mm

This data sheet is designed as a guide and should not be regarded as wholly accurate in every detail. We reserve the right to amend the specification of any product without notice.