

ART 105

PN16 Ductile Iron Gate Valve



Features

- Flanged Mounting PN16 only
- BS EN558-1 Series 14
- DIN 3352F4

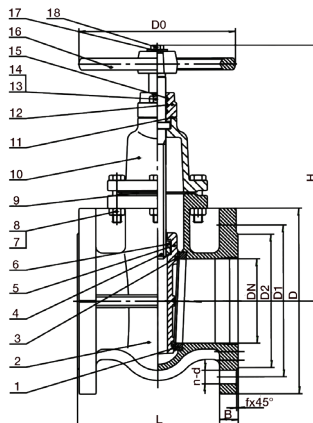

Technical data

Max pressure: 16 Bar

Working temp: -10°C to +200°C

DN	50	65	80	100	125	150	200	250	300
L	150	170	180	190	200	210	230	250	270
D	165	185	200	220	250	285	340	405	460
D1	125	145	160	180	210	240	295	355	410
D2	99	118	132	156	184	211	266	319	370
B	16	16	17	17	18	20	21	23	24
f	2	2	2	2	3	3	3	3	4
n-d	4-19	4-19	8-19	8-19	8-19	8-23	12-23	12-28	12-28
D0	160	160	160	200	200	250	250	320	320
H	204	226	254	295	351	413	498	579	679
Kgs	11	15	18	22	31	40	60	85	135

N.	Part Name	Materials
1	Body Seat Ring	Cast Brass DIN17656 G-CuZn37Pb
2	Body	Ductile Iron DIN1693 GGG50
3	Wedge Seat Ring	Cast Brass DIN17656 G-CuZn37Pb
4	Stem	Stainless Steel DIN17440 X20Cr13
5	Wedge	Ductile Iron DIN1693 GGG50
6	Stem Nut	Cast Brass
7	Bolt	Steel DIN17100 RSt37-2
8	Nut	Steel DIN17100 RSt37-2
9	Flange Gasket	Graphite
10	Bonnet	Ductile Iron DIN1693 GGG50
11	Stuffing Box Gasket	
12	Stuffing Box	Ductile Iron DIN1693 GGG50
13	Bolt	Steel DIN17100 RSt37-2
14	Nut	Steel DIN17100 RSt37-2
15	O-Ring	NBR
16	Handwheel	Cast Iron DIN1691 GG25
17	Washer	Steel DIN17100 RSt37-2
18	Bolt	Steel DIN17100 RSt37-2

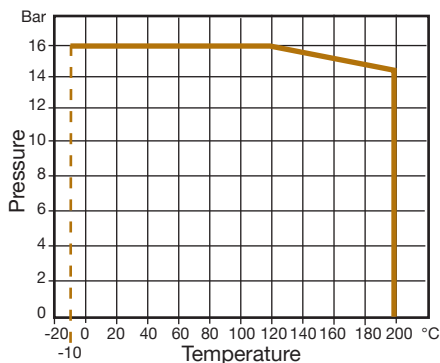

V3. Dimensions in mm

This data sheet is designed as a guide and should not be regarded as wholly accurate in every detail. We reserve the right to amend the specification of any product without notice.